

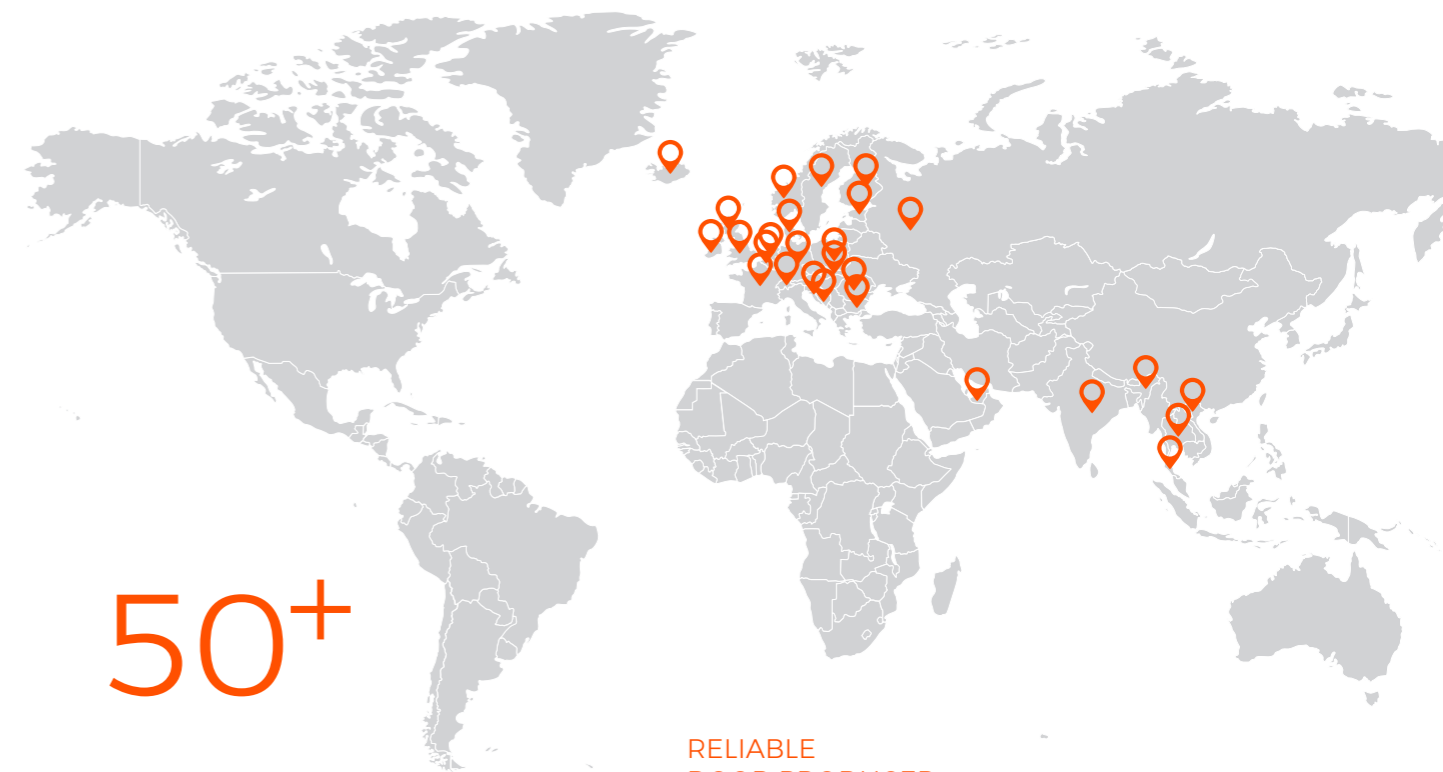

INDY
INDUSTRIAL DOORS



We develop doors both Industrial and Residential. 20 years of market experience can tell our story.



50+

**RELIABLE
DOOR PRODUCER**

- Supplies to more than 50 countries worldwide
- Cooperation with renowned suppliers of door components
- Quality Management System, Automated Production and Quality Control
- Professional customer service, Complex door configuration

OPTIMIZED SOLUTIONS

- We design and produce doors according to standard/non-standard request
- Various possibilities of modification in non-standard cases: oversize, track deflection, track length, etc...



HSE (Health & Safety & Environment)

Certification according to EN 13241-1

Toors is significant member of **EDSF** (European Door and Shutter Federation)



BASIC SPECIFICATION

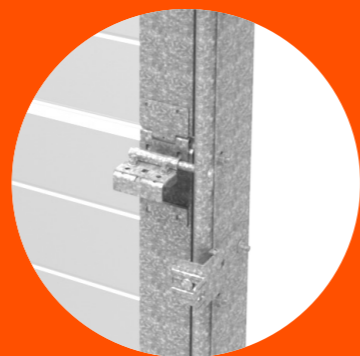
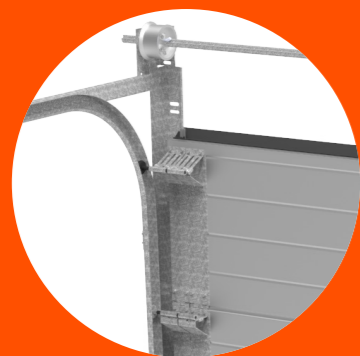

Quality and safety of TOORS sectional doors is at the first place. TOORS sectional doors are produced from a quality materials and components, supplied by distinguished European suppliers. Complete process of production is countinously controlled to ensure customer's satisfaction, at all requests.

TOORS sectional doors fullfill European norms related to door technics and tested by harmonised norm EN 13241-1.

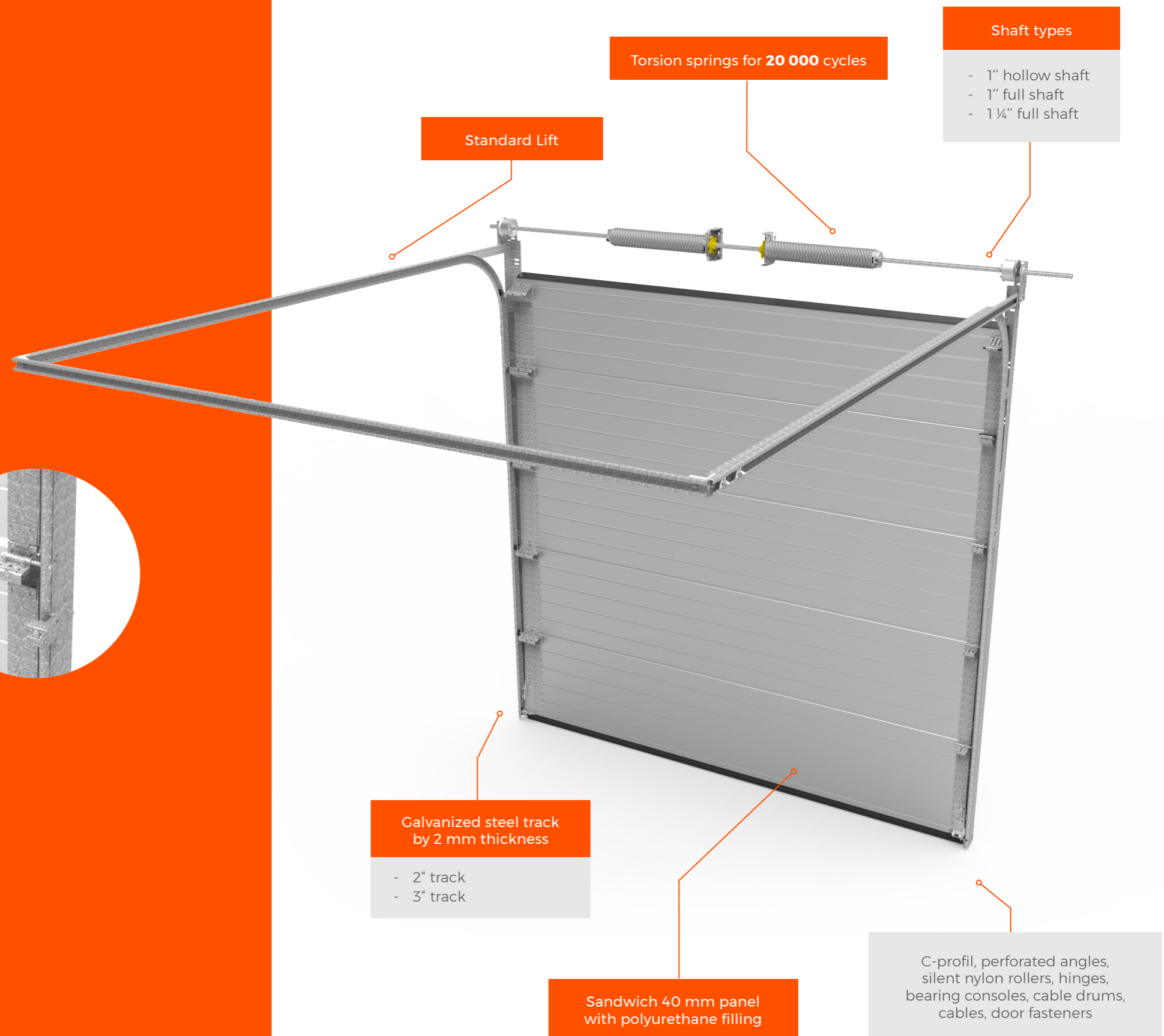

LIFT TYPE

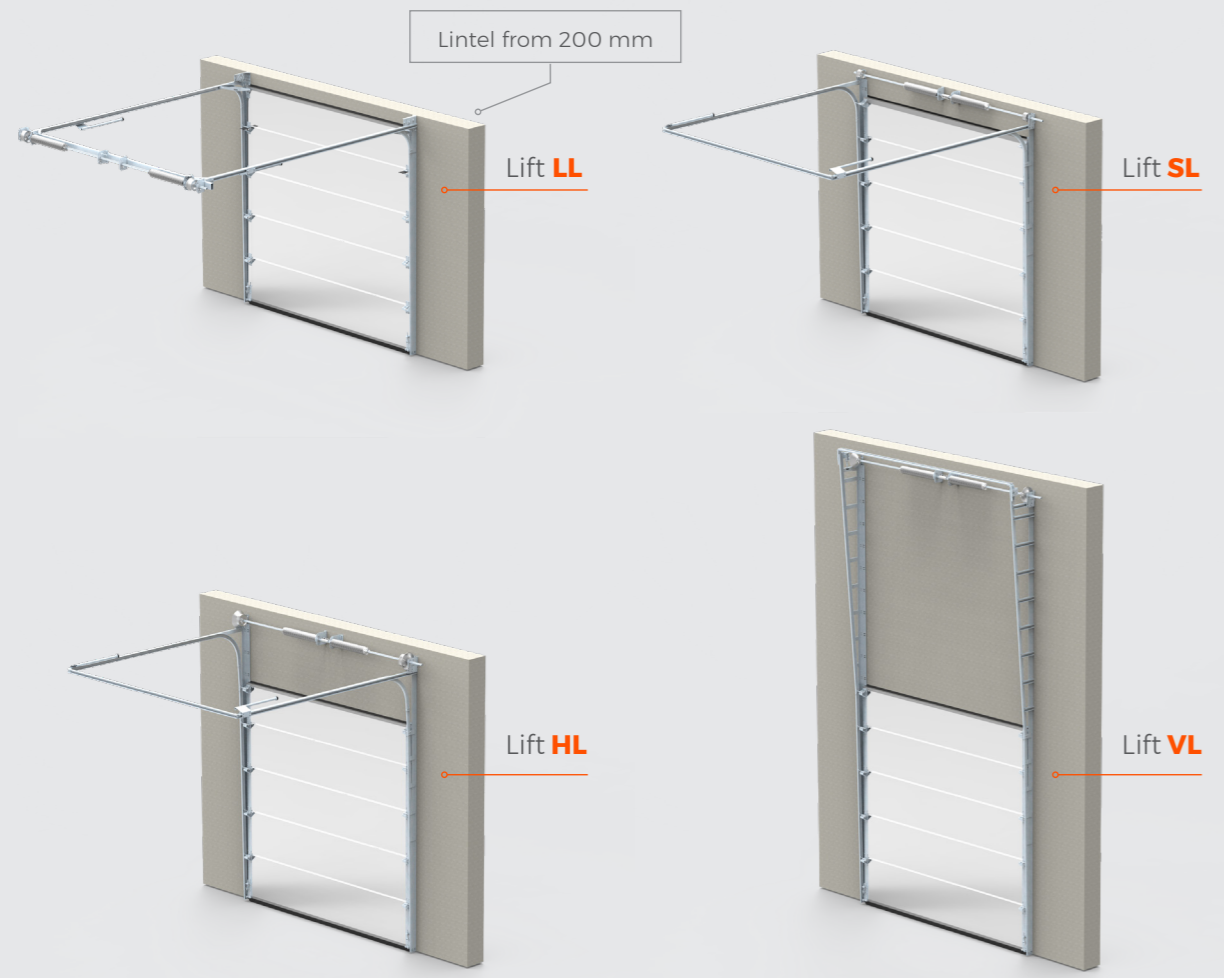

Lift Type	Subcategory	Max. m ²	Max. dimension
LL - Low Lift	LL-CE	23 m ²	6 000 × 5 000
	LL-DT	23 m ²	6 000 × 5 000
SL - Standart Lift	SL350	25 m ²	7 000 × 3 600
	SL420	40 m ²	8 000 × 6 500
HL - Vertical Lift	HL	40 m ²	8 000 × 6 500
	HL-T1	16 m ²	4 000 × 4 000
	HL-T2	25 m ²	5 000 × 5 500
VL - High Lift	VL	40 m ²	8 000 × 6 500
	VL-T	25 m ²	5 000 × 5 500



FSL
Standart Lift under 15° angle

TRACK UNDER ANGLE
Horizontal track can be under angle copying the roof angle up to 45°.

DOUBLE ANGLED TRACK
Possibility of double angled track helps to conform any roof shape.

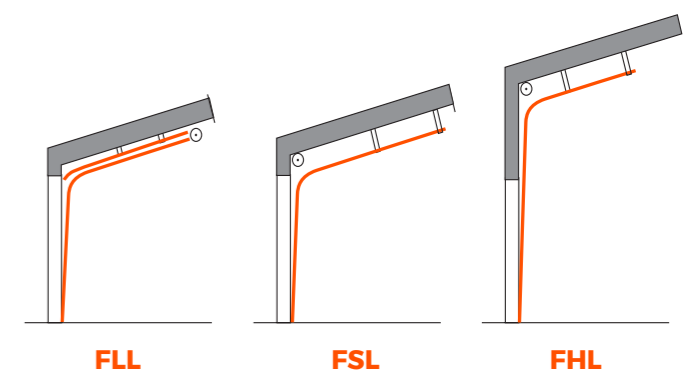

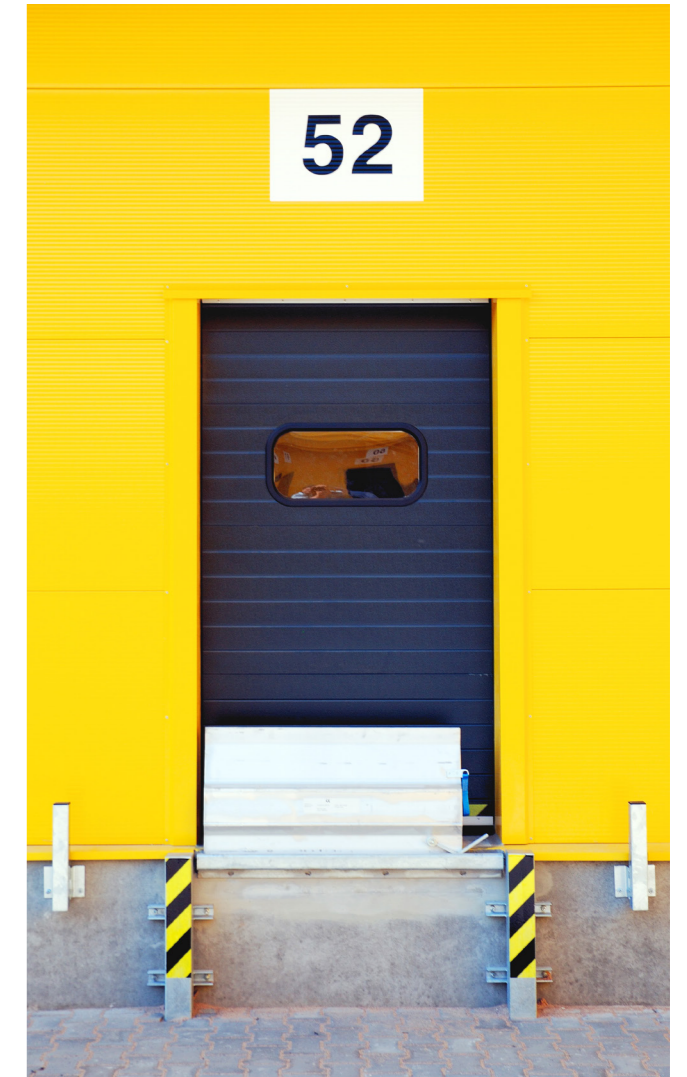

We aim to overhead door production. At our disposal, we have top notch machinal equipment and sufficient production capacity to cover increasing demand.



Sandwich panel is made by two both-side galvanized steel sheets. In between, there is polyurethane foam, which performs thermal and noise isolation. Standard panel thickness is 40 mm, but we also offer 80 mm panel with better thermal and noise isolation. We offer panels by 40 mm in designs STANDARD and PROTECT (finger safe protection).

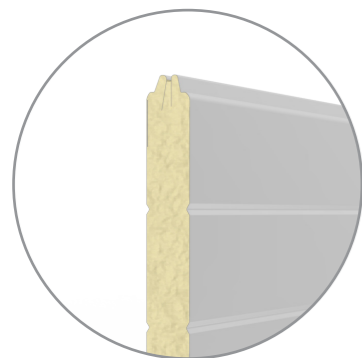

Standard 40 mm

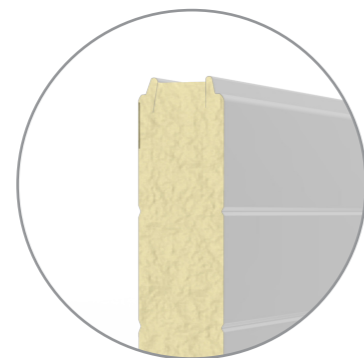

Standard 80 mm

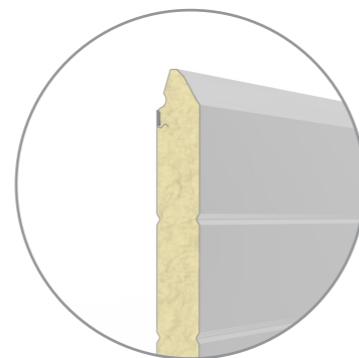

Protect 40 mm

DESIGN

DESIGN STANDARD

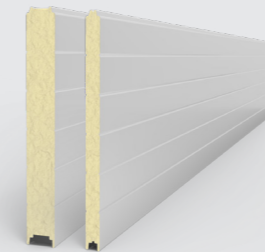

Surface structure

lamella stucco

Outside color

according to current panel range

Innside color

according to current panel range

Traditional panel shape | Polyurethane foam core |

Double-side hot dip galvanizing |

U = 0,50 W/m²K | R = 25 dB



40 mm / 80 mm

DESIGN PROTECT

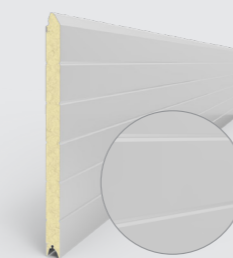

Surface structure

lamella stucco / lamella flat

Outside color

according to current panel range

Innside color

according to current panel range

Finger safe protection (FSP) | Polyurethane foam core |

Double-side hot dip galvanizing |

U = 0,52 W/m²K | R = 25 dB

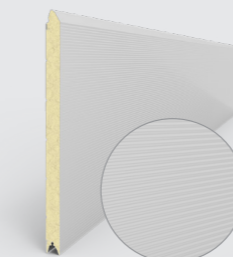

Surface structure

V-profile smooth

Outside color

according to current panel range

Innside color

according to current panel range

Finger safe protection (FSP) | Polyurethane foam core |

Double-side hot dip galvanizing |

U = 0,52 W/m²K | R = 25 dB

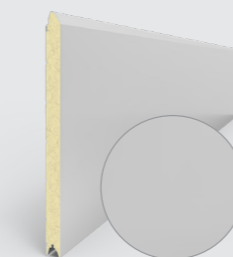

Surface structure

flat smooth

Outside color

according to current panel range

Innside color

according to current panel range

Finger safe protection (FSP) | Polyurethane foam core |

Double-side hot dip galvanizing |

U = 0,52 W/m²K | R = 25 dB



ALUMINIUM FULLY GLAZED SECTIONS - FVE

TECHNICAL PREFERENCES

- Standard design with anodized aluminium frame E6/EV1
- Variable design for STANDART and PROTECT panel with and without broken thermal bridge
- Choice of different fillings depending on design, thermal insulation properties and air permeability
- Possibility of additional painting of aluminium frames to RAL, NCS, DB
- Anti-scratch

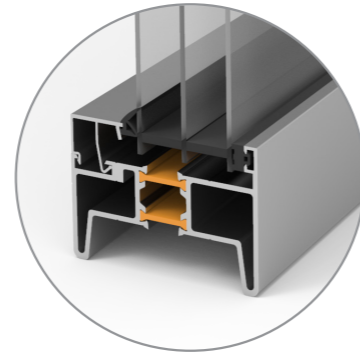

DESIGN WITHOUT BROKEN THERMAL BRIDGE

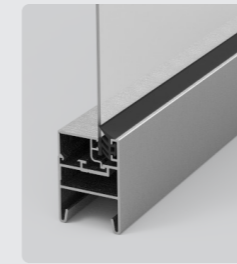

Single

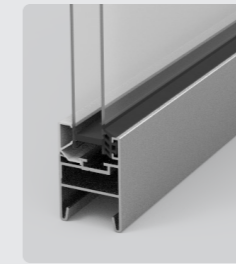

Double

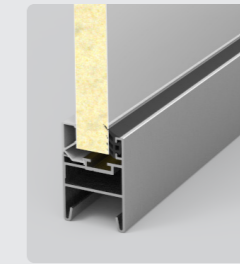

Stucco Filling

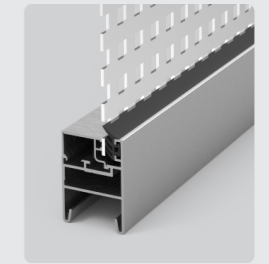

Aluminium Expanded Mesh

DESIGN WITH BROKEN THERMAL BRIDGE

- For panels STANDARD and PROTECT (40 mm and 80 mm)
- Design identical with current fully glazed solution with finger save protection
- Excellent insulating properties (decreased heat permeability up to 22%)
- Stopped water condensation on innerside (Exterior vs Interior)



FVE TB - 40 mm

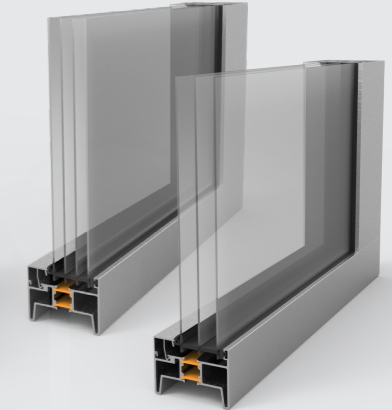

FVE TB - 80 mm

Example:

Design	FVE 40 mm	FVE TB 40 mm
Width	4 500	4 500
Height	3 500	3 500
Thermal permeability	3,8 W/m ² K	3,1 W/m ² K
Air tightness	3	3
Wind resistance	3	4
Water tightness	3	3

DECREASE OF HEAT PERMEABILITY UP TO

22%



TOORS Indy doors you can find in production halls, logistics centers, car shows. Wherever needed to ensure flawless operations.

TOORS Indy doors provide high comfort of control, easy service and energy savings expended to heating/air conditioning of premises.

TOORS Indy doors meet the highest demand for operations.

PASS DOOR

TECHNICAL PREFERENCES

- Installation of pass door up to 30 m² door leaf
- Option to chose threshold- standard, low
- Anodized aluminium profiles E6/EV1
- Easy and fast installation
- Integrated steel reinforcement strut bellow door closer
- Possibility of additional painting to RAL, NCS, DB

THRESHOLD HEIGHTS

Section	Threshold	Height
Panel	low	18 mm
FVE	low	18 mm
Panel	standard	225 mm
FVE	standard	130 mm

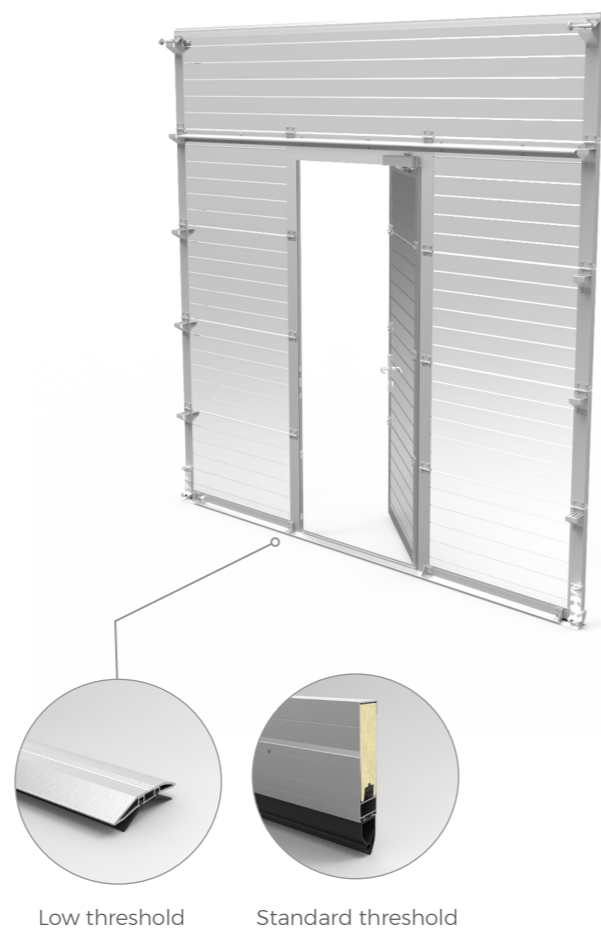

Low threshold Standard threshold

BY USING LOW THRESHOLD THE NORM OF EMERGENCY EXIT IS MET



PARAMETERS

Door height	1. - 4. section composition	Threshold	Handle height
2 300 mm	4 x 610 mm	Low	980 mm
		Standard	1 030 mm
2 190 mm	3 x 610 mm 1 x 500 mm	Low	980 mm
		Standard	1 030 mm
2 080 mm	2 x 610 mm 2 x 500 mm	Low	980 mm
		Standard	1 030 mm
1 970 mm	1 x 610 mm 3 x 500 mm	Low	980 mm
		Standard	1 030 mm
1 860 mm	4 x 500 mm	Low	870 mm
		Standard	920 mm



ACCESSORIES

- Panic lock in various designs
- Electric lock
- Possibility of placed window or fully glazed sections

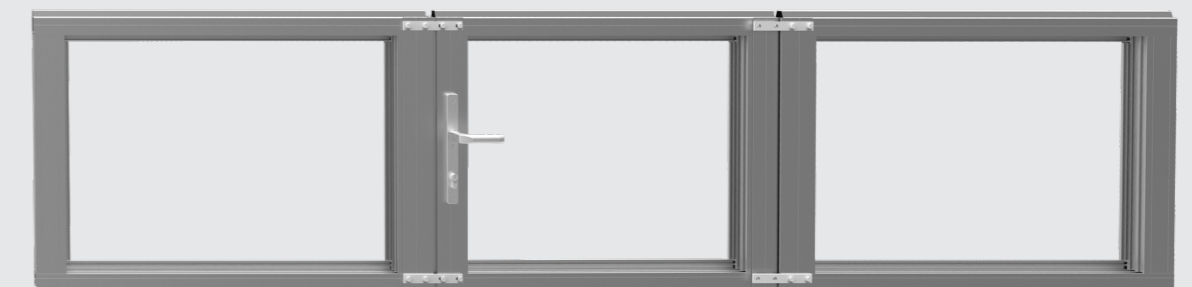
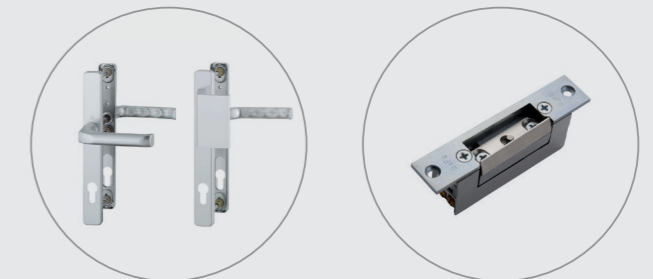

DOOR OPERATORS

PARAMETERS

- Electronic limit switches
- Protection IP65
- Voltage 400V/230V
- Emergency operation by: chain (SK), declutching (ER)
- Opening speed 20-50 cm/sec
- Operator with Frequency Inverter



ACCESSORIES

OPTION OF ADDITIONS

Wide range of accessories and safety elements for new doors or as addition to already installed doors.



TOTMAN - Control Unit TS970

IMPULS - Control Unit TS970

- Optical features + 2pcs of cable break switch
- Spiral Cable/WSD Module + connection boxes

IMPULS + remote control - Control Unit TS971

- Optical features + 2pcs of cable break switch
- Spiral Cable/WSD Module + connection boxes
- Frequency 433 MHz



Spare Parts and Accessories you can purchase via specialised website TOORS SERVICE, where full portfolio can be found.

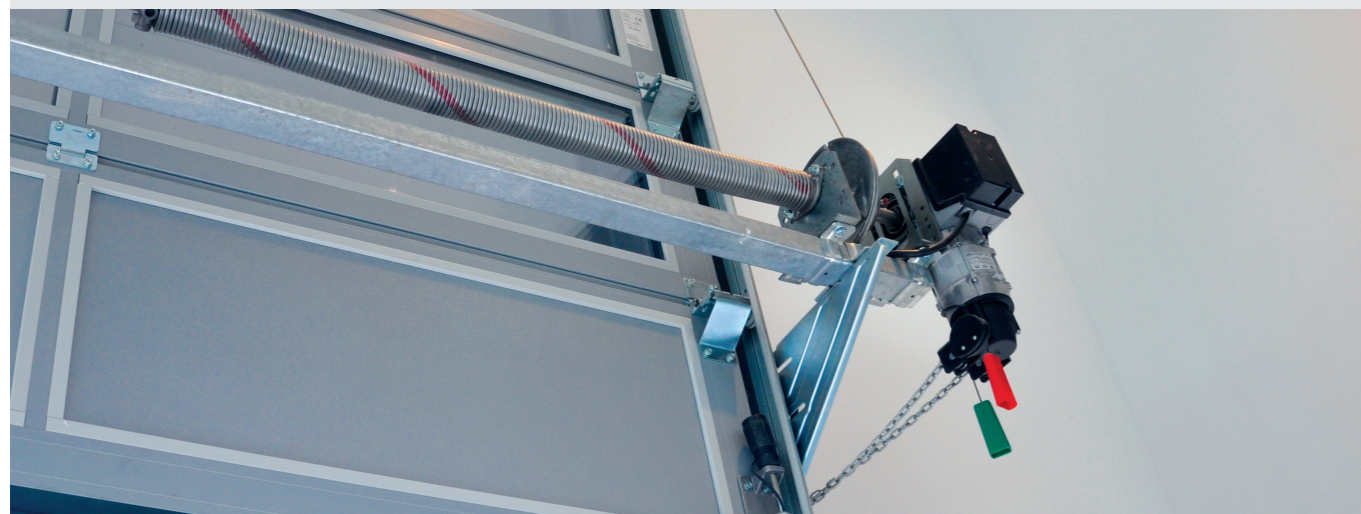



TOORS Indy can contain aluminium fully glazed sections, except of attractive design, ensure better light conditions in halls or the fresh air access by using of special fillings.

Addition of TOORS Indy can be pass door together with low threshold, which meet the claims for emergency exits.

DEMANDING CONDITIONS

We produce doors even for extremely demanding conditions.

Possibility of additional components from stainless steel, paints for food industry or reinforcing of construction to hard windy conditions.

USAGE:

- Wet surroundings
- Food industry
- Agricultural industry
- Aerial industry
- Navi

STAINLESS STEEL COMPONENTS

- Tracks
- End caps
- Hardware
- Spring bumpers
- Bottom bracket
- Wires

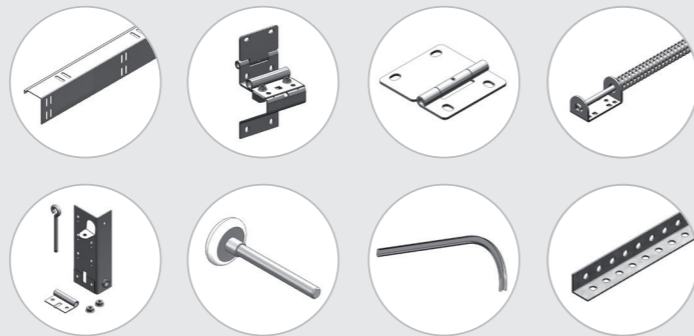

UNDERGROUND GARAGES

With use of industrial door operator with frequency inverter for high-capacity garages.

Optimum air permeability (56% / 67%)

Variability of control - key switch | remote control | traffic light | microwave radar | induction loop

- Wide range of accessories
- Control Unit TS981 for two-way traffic
- External photocells
- Pass Door with panic lock for need of emergency exit
- Up to 256 pcs remote controls can be used

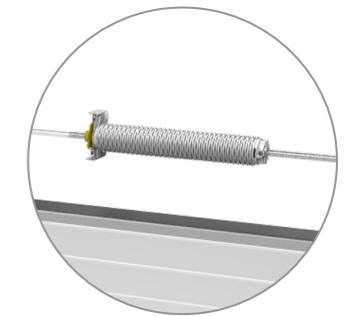

SPRINGS UP TO
150 000
CYCLES



BIM PROCESS

- Use for building of family houses up to logistics centers
- BIM segment technologies with advantage of our BIM patterns
- Patterns for industrial doors, residential doors and Mandoor
- Particular construction elements are described by 3D pattern data file (with properties)

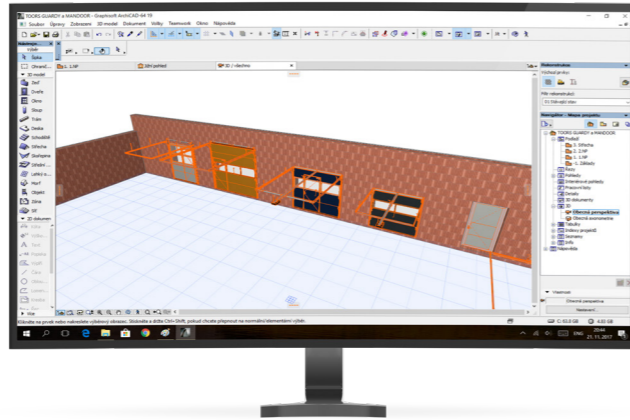

Download on www.bim.toors.com



STOORe

Configurator of all door types- Industrial door, Residential door, Double Leaf door, Mandoor.

FUNCTIONS:

- Web interface available from PC, smart phone or tablet
- Fast and easy door specification
- Quotation immediately available for the end customer
- Requested documentation right on hand
- Overview of valid quotations and orders
- Visualisation of configured door

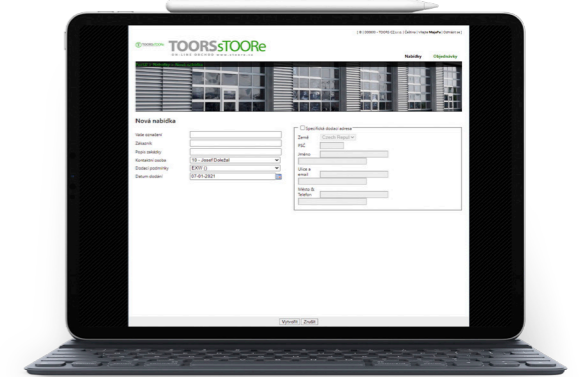

DOOR CONFIGURATION AT DISPOSAL IN SEVERAL LANGUAGE MUTATIONS

BIM LIBRARIES

Our rigorously processed patterns increase probability of their further use, for example by architects or designers in comparison to currently lower quality patterns of the others, which do not meet the reality.

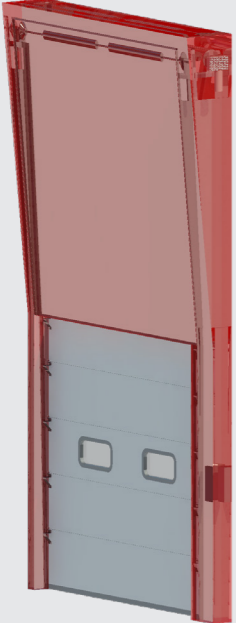

INDY
- industrial doors



GUARDY
- residential doors

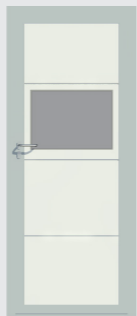

MANDOOR
- mandoor





TOORS Indy offer either endurance, functionality, certified safety and variable design.

TOORS Indy meet all the highest claims for operation and also fit to overall look of the building concept in parallel.

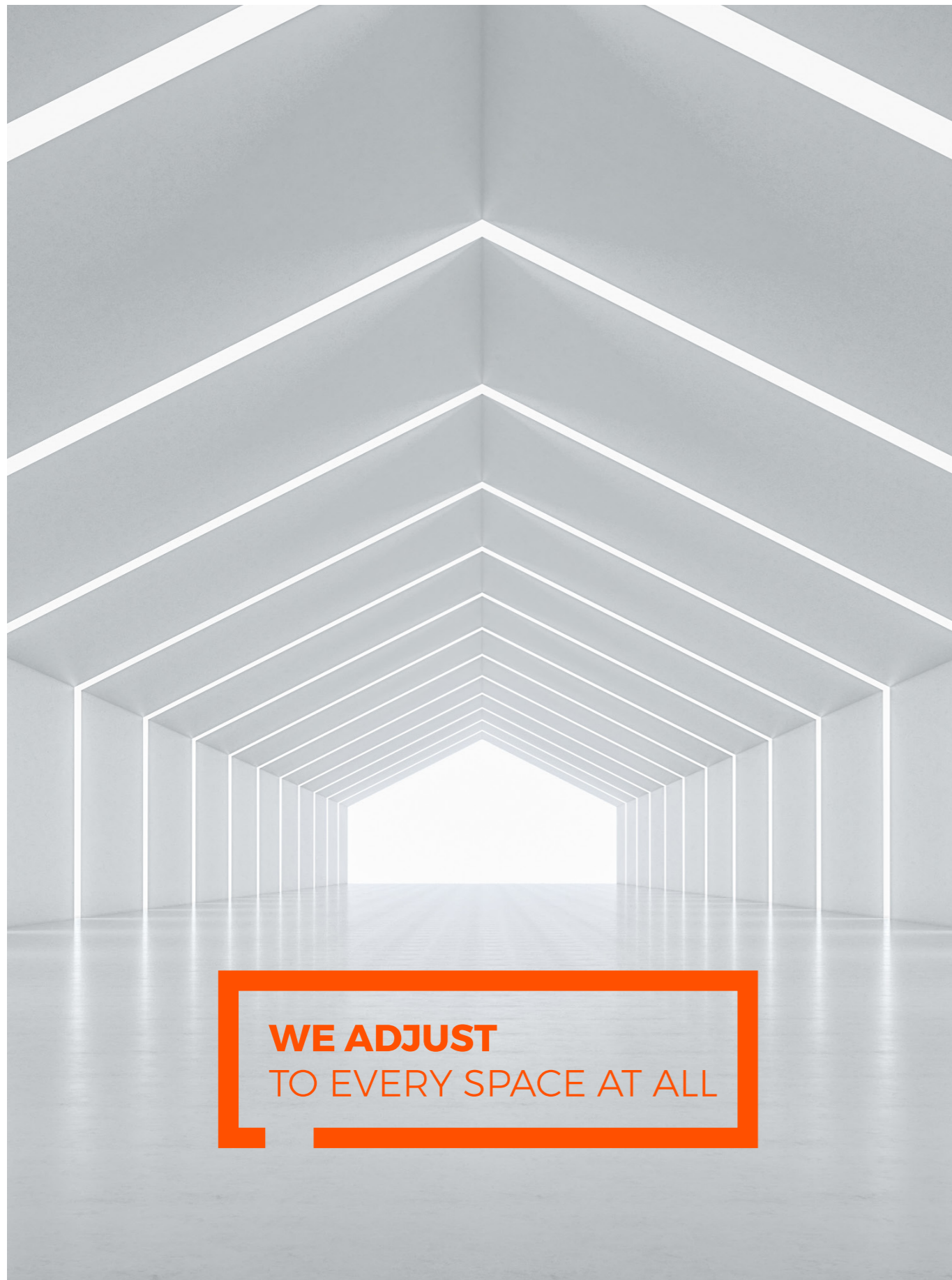

**WE ADJUST
TO EVERY SPACE AT ALL**

MEASUREMENT PROTOCOL

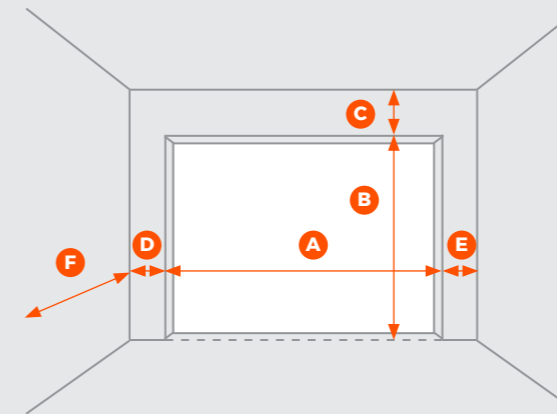

A - Width		mm.
B - Height		mm.
C - Lintel		mm.
D - Left side		mm.
E - Right side		mm.
F - Space Depth		mm.
Shaft Length		mm.
Angle		%

Door Parameters	Yes	No	Specification
Windows / FVE sections			
Panel design			
Fixed top panel			
Pass Door			
Handle and lock type			
Door operator			
Previous door removal			
Previous door disposal			
Forklift at site			

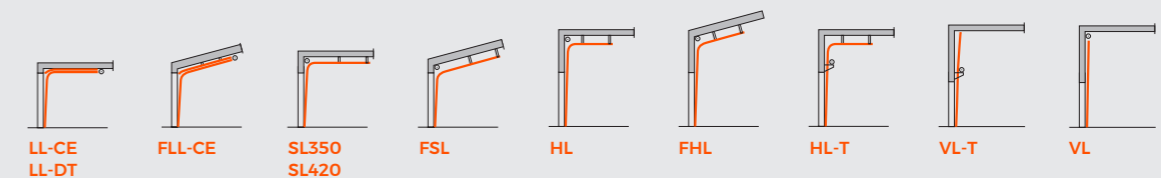

Customer address

.....

Name of the installer

.....

Note:

.....

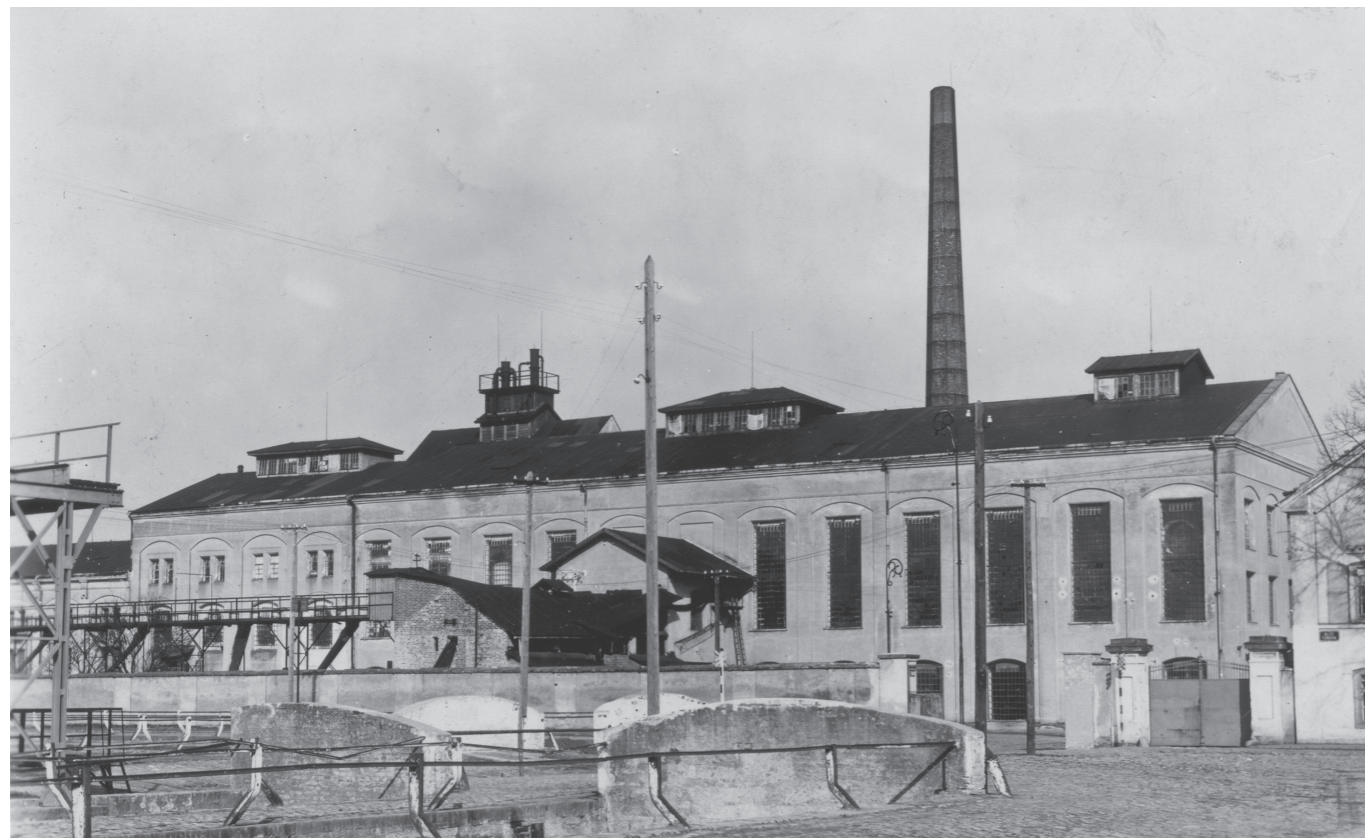

HISTORY OF TOORS

THIS IS WHERE WE PRODUCED OUR FIRST DOOR.

THIS IS WHERE IT ALL STARTED

It's been a quarter of a century we decided to build our business on respect to customers, suppliers, colleagues and others.

AND TODAY?

TOORS stands for great professionals in the European door industry. We are conquering the world slowly but surely.

GENERAL COMPANY DATA	
COMPANY ESTABLISHED	2 000
TURNOVER 2019	20 MIO €
DOORS PRODUCED 2019	20 000 PCS
DOORS TO BE PRODUCED 2023	36 000 PCS
EMPLOYEES	135
EDSF (European Door & Shutter Federation)	Since 2010
LAND AREA	18 000 m ²
PRODUCTION & WAREHOUSE	12 000 m ²
NUMBER OF COUNTRIES WHERE WE OPERATE	50+



PRODUCTION CAPACITY
+30 000 PCS
PER YEAR

DEVELOPMENT OF TOORS



THREE BASIC PILLARS OF TOORS COMPANY CULTURE



EASY COOPERATION

- Friendly communication
- Minimum of bureaucracy
- Flexible and fast decision chain



LEAN THINKING

- Openness for changes
- Smart efficiency and cost savings
- Added value focus



FREEDOM WORKS

- Responsibility build freedom
- Respect and fair treatment
- Leadership and enthusiasm



TOORS CZ s.r.o.

Turkova 1338

504 01 Nový Bydžov

+420 495 491 855 | toors@toors.cz

www.toors.com

